

MAL209674152E3

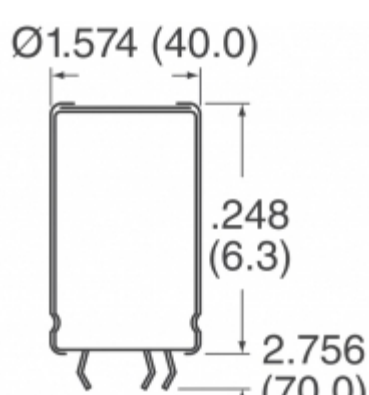

Part Number: MAL209674152E3
Manufacturer: Electro-Films (EFI) / Vishay
Description: CAP ALUM 1500UF 20% 420V SNAP
Data sheet: [096 PLL-4TSI \(MAL2096\) Series](#)
[Aluminum Electrolytic Capacitors Guide](#)

RoHS Status: Lead free / RoHS Compliant
Ship From: Hong Kong
Shipment Way: DHL/Fedex/TNT/UPS/EMS

Images are for reference only.
 See Product Specifications for product details.
Buy MAL209674152E3 with confidence from Component-World.HK, 1 Year Warranty



[Request For Quotation](#)

PRODUCT PARAMETER

Part Number	MAL209674152E3	Manufacturer	Electro-Films (EFI) / Vishay
Description	CAP ALUM 1500UF 20% 420V SNAP	Lead Free Status / RoHS Status	Lead free / RoHS Compliant
Quantity Available	3770 pcs	Data sheet	096 PLL-4TSI (MAL2096) Series Aluminum Electrolytic Capacitors Guide
Category	Capacitors	Voltage - Rated	420V
Tolerance	±20%	Surface Mount Land Size	-
Size / Dimension	1.575" Dia (40.00mm)	Series	096 PLL-4TSI
Ripple Current @ Low Frequency	7.2A @ 100Hz	Ratings	-
Polarization	Polar	Packaging	Tape & Box (TB)
Package / Case	Radial, Can - 5 Lead	Operating Temperature	-40°C ~ 85°C
Mounting Type	Through Hole	Moisture Sensitivity Level (MSL)	1 (Unlimited)
Manufacturer Standard Lead Time	15 Weeks	Lifetime @ Temp.	5000 Hrs @ 85°C
Lead Spacing	0.787" (20.00mm)	Lead Free Status / RoHS Status	Lead free / RoHS Compliant
Impedance	42 mOhms	Height - Seated (Max)	4.134" (105.00mm)
ESR (Equivalent Series Resistance)	217 mOhm @ 100Hz	Detailed Description	1500µF 420V Aluminum Electrolytic Capacitors Radial, Can - 5 Lead 217 mOhm @ 100Hz 5000 Hrs @ 85°C
Capacitance	1500µF	Applications	General Purpose

Component-World.com is a Reliable Stocking Distributor of Electronic Components. We specialize in all Electro-Films (EFI) / Vishay series electronic components. We have 3770 pieces of Electro-Films (EFI) / Vishay MAL209674152E3 in stock available now. Request a quote from electronics components distributor at Component-World.com, our sales team will contact you within 24 hours.
 RFQ Email: info@Components-World.com

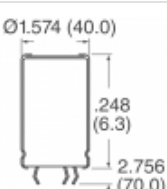
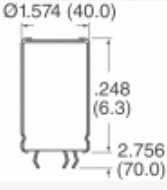
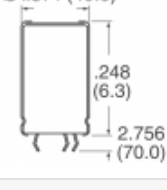
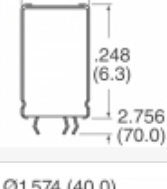
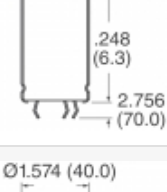
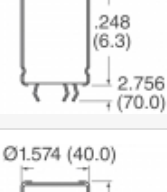
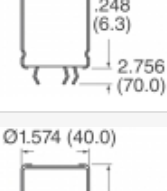
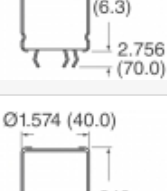
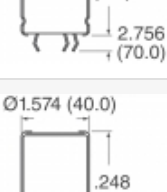
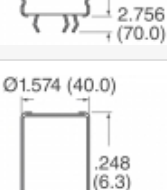
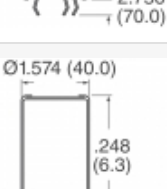
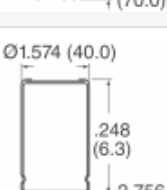
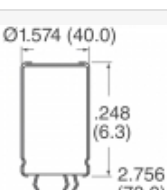
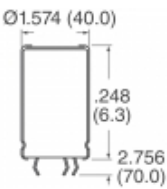
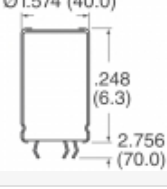
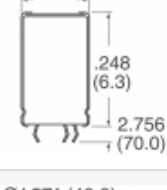
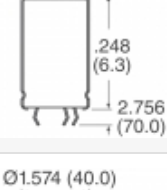
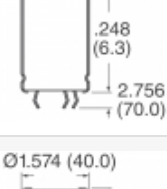
RELATED PRODUCTS

	Part#: MAL209669821E3 Description: CAP ALUM 820UF 20% 500V SNAP	Manufacturers: Electro-Films (EFI) / Vishay	RFQ
	Part#: MAL209674102E3 Description: CAP ALUM 1000UF 20% 420V SNAP	Manufacturers: Electro-Films (EFI) / Vishay	RFQ
	Part#: MAL209669561E3 Description: CAP ALUM 560UF 20% 500V SNAP	Manufacturers: Electro-Films (EFI) / Vishay	RFQ
	Part#: MAL209675102E3 Description: CAP ALUM 1000UF 20% 350V SNAP	Manufacturers: Electro-Films (EFI) / Vishay	RFQ
	Part#: MAL209668122E3 Description: CAP ALUM 1200UF 20% 385V SNAP	Manufacturers: Electro-Films (EFI) / Vishay	RFQ
	Part#: MAL209674182E3 Description: CAP ALUM 1800UF 20% 420V SNAP	Manufacturers: Electro-Films (EFI) / Vishay	RFQ
	Part#: MAL209668681E3 Description: CAP ALUM 680UF 20% 385V SNAP	Manufacturers: Electro-Films (EFI) / Vishay	RFQ
	Part#: MAL209669681E3 Description: CAP ALUM 680UF 20% 500V SNAP	Manufacturers: Electro-Films (EFI) / Vishay	RFQ
	Part#: MAL209674821E3 Description: CAP ALUM 820UF 20% 420V SNAP	Manufacturers: Electro-Films (EFI) / Vishay	RFQ
	Part#: MAL209676102E3 Description: CAP ALUM 1000UF 20% 400V SNAP	Manufacturers: Electro-Films (EFI) / Vishay	RFQ
	Part#: MAL209675182E3 Description: CAP ALUM 1800UF 20% 350V SNAP	Manufacturers: Electro-Films (EFI) / Vishay	RFQ
	Part#: MAL209668821E3 Description: CAP ALUM 820UF 20% 385V SNAP	Manufacturers: Electro-Films (EFI) / Vishay	RFQ
	Part#: MAL209675821E3 Description: CAP ALUM 820UF 20% 350V SNAP	Manufacturers: Electro-Films (EFI) / Vishay	RFQ
	Part#: MAL209675122E3 Description: CAP ALUM 1200UF 20% 350V SNAP	Manufacturers: Electro-Films (EFI) / Vishay	RFQ
	Part#: MAL209669471E3 Description: CAP ALUM 470UF 20% 500V SNAP	Manufacturers: Electro-Films (EFI) / Vishay	RFQ
	Part#: MAL209675222E3 Description: CAP ALUM 2200UF 20% 350V SNAP	Manufacturers: Electro-Films (EFI) / Vishay	RFQ
	Part#: MAL209669391E3 Description: CAP ALUM 390UF 20% 500V SNAP	Manufacturers: Electro-Films (EFI) / Vishay	RFQ
	Part#: MAL209674122E3 Description: CAP ALUM 1200UF 20% 420V SNAP	Manufacturers: Electro-Films (EFI) / Vishay	RFQ
	Part#: MAL209675152E3 Description: CAP ALUM 1500UF 20% 350V SNAP	Manufacturers: Electro-Films (EFI) / Vishay	RFQ
	Part#: MAL209674681E3 Description: CAP ALUM 680UF 20% 420V SNAP	Manufacturers: Electro-Films (EFI) / Vishay	RFQ

Related keywords for MAL209674152E3

Electro-Films (EFI) / Vishay MAL209674152E3	MAL209674152E3 distributor	MAL209674152E3 supplier	MAL209674152E3 price
MAL209674152E3 download datasheet	MAL209674152E3 datasheet	MAL209674152E3 stock	buy MAL209674152E3
Electro-Films (EFI) / Vishay MAL209674152E3	Electro-Films (EFI) / Vishay MAL209674152E3	Vishay Electro-Films MAL209674152E3	Phoenix Passive Components / Vishay MAL209674152E3